



A-UNIQUE

ASIA UNIQUE LED LIGHTING CO., LTD

Tri-wattage LED Batten

AU02-BAT Series

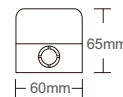
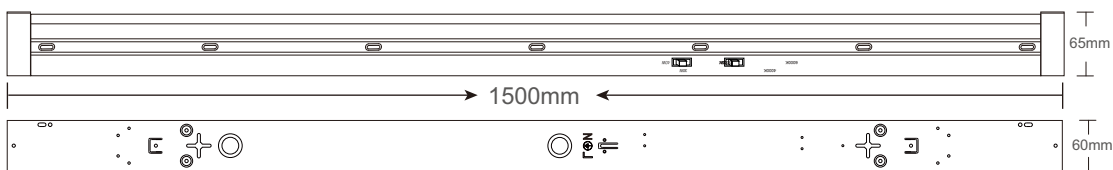
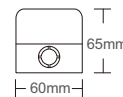
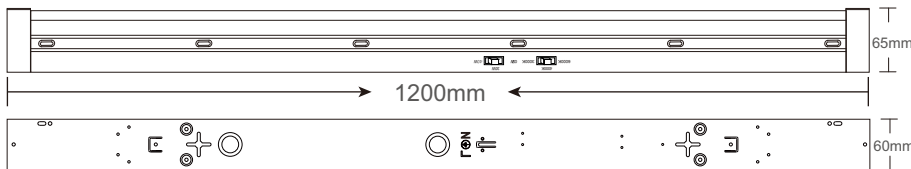
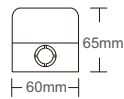
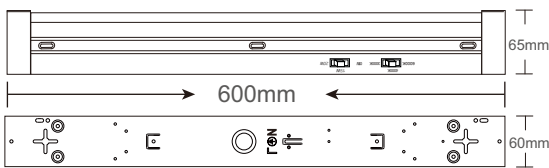
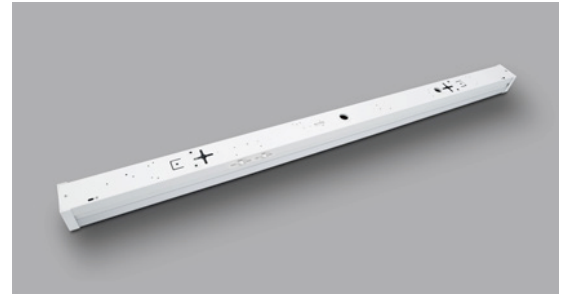
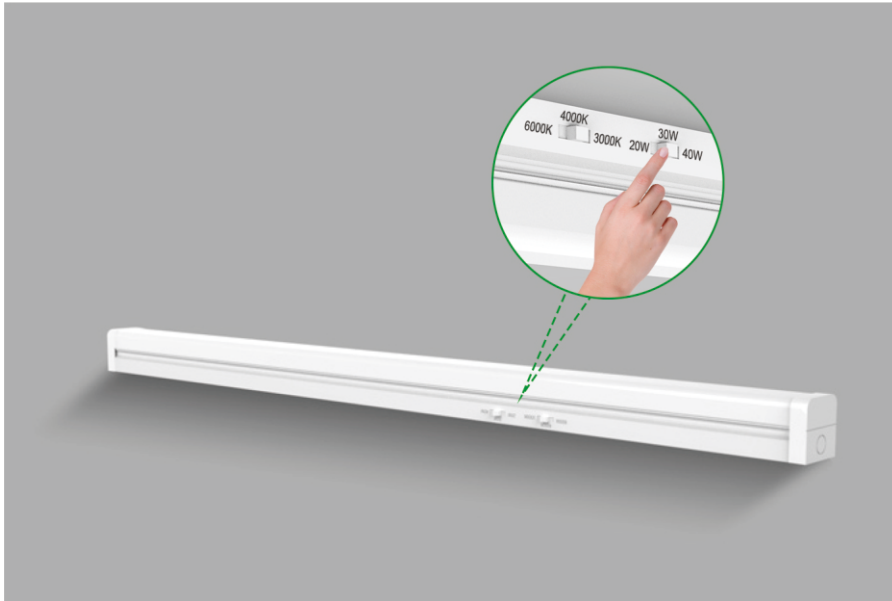



General Features:

- Tri-wattage selectable by dip switch before installation
- Tri-color selectable by dip switch available
- Wire from back or two ends, with big entry hole
- Big Terminal Block or Quick play & plug connector, easy installation
- LED Replaceable board, very even light distribution
- Suspension strap attached to the lamp & base part, makes installation easier
- Can be Surface Mounted or Suspended
- Can be linked one to another, end by end, without gap
- CE, Rohs, SAA & C-tick approved
- Sensor & Emergency versions are available
- Triac Dimming, 1-10V Dimming & Dali Dimming available

Technical Specifications

Model No.	AU02-BAT101520W2F3C	AU02-BAT203040W4F3C	AU02-BAT203040W5F3C
Dimension(mm)	600*60*65	1200*60*65	1500*60*65
Cutout(mm)	/	/	/
Wattage(w)	10W-15W-20W	20W-30W-40W	20W-30W-40W
Input Voltage(v)	AC220~240V		
Light Source	SMD2835		
SDCM	<6		
CCT(K) 3 CCT	3000K-4000K-6000K or as per your requirement		
Luminous Flux (lm)?%	1150-2800	2300-5600	2300-5600
CRI	>80Ra		
Beam Angle(?)	120°		
Dimming option	Non-dimmable, Flicker Free		
Sensor option	Available		
Emergency Kits	Available		
Protection Class	Class I		
Degree of protection(IP)	IP20		
Impact Resistance(IK)	IK08		
Material	Frame	Iron	
	Heatsink	PC	
	Diffuser	PC	
L70	>54000Hrs		
Glow Wire Test(°C)	650°C		
Operation Temp.(°C)	-20~ 45°C		
Installation	Surface Mounted / Suspended		
Certificates	CE, Rohs, SAA & C-tick		
Warranty	3 Years		

Packing information

Model Number	Weight/Luminaire (kg)	QTY/BOX (pcs)	Inner Box Size (mm)	Weight/Box (kg)	QTY/CTN (pcs)	Carton Size (cm)	Weight/CTN (kg)	QTY/20GP (PCS)	QTY/40GP (PCS)	QTY/40HQ (PCS)
AU02-BAT101520W2F3C	0.63	1	620*70*75	0.73	8	63.5*29.5*17	7.9	7232	15152	17176
AU02-BAT203040W4F3C	1.00	1	1215*70*75	1.2	6	122*22.5*17	8.2	3222	7332	8412
AU02-BAT203040W5F3C	1.25	1	1515*70*75	1.6	6	152*22.5*17	10.5	2730	5928	6768

Installation Instructions

Step 1:

Turn off the power supply, slide the end caps, remove the LED diffuser part from the base housing
Select the suitable CCT & Wattage by dip switch

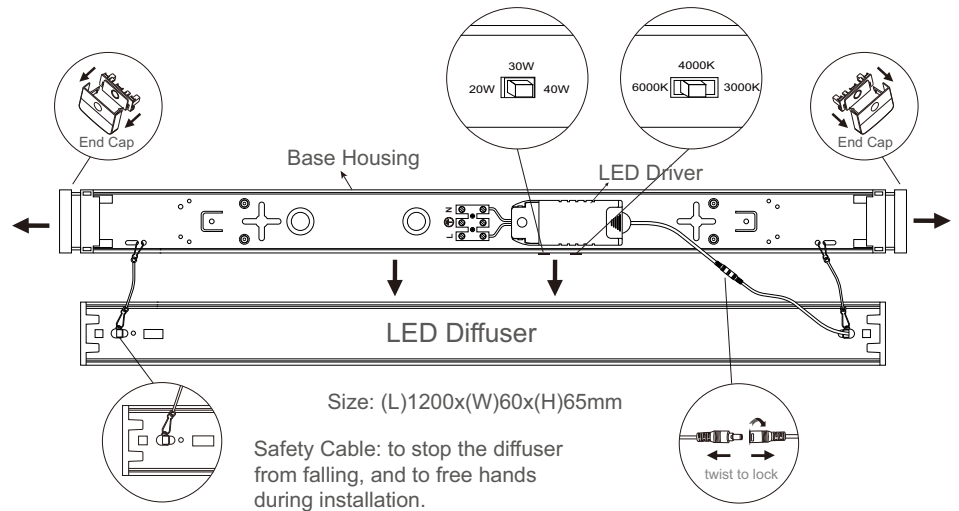

Step 2: Mount the fitting onto ceiling with wall plugs and screws

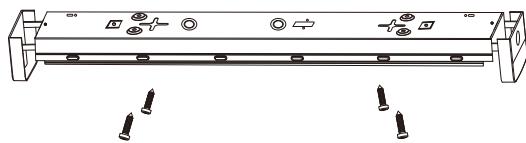

Surface Mounted

Step 2: Secure the mounting bracket to the steel cable

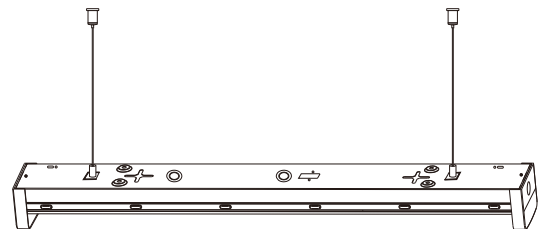

Suspended Mounted

Step 3: Wire the cable into the terminal block through the cable entry hole Insert connector between the base and diffuser; Assemble the diffuser back to the base and also the two caps.

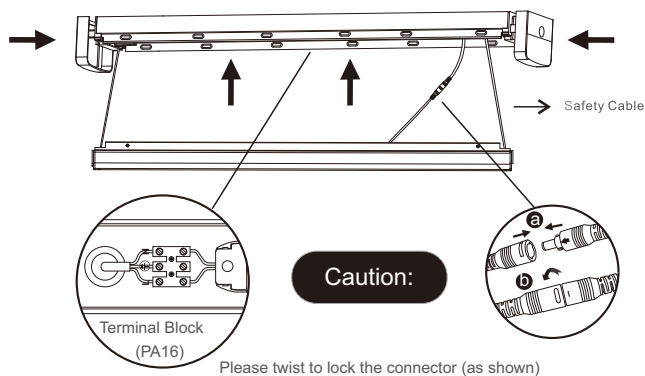

Step 4: Turn on the power supply to ensure the luminaire is working properly.

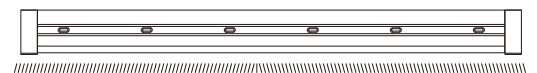

Packing List (each inner box)

LED Batten	1piece
Screw	4pcs
Wall Plug	4pcs

Please Note:

- * Turn off and isolate the electrical supply before connecting this fitting to the building wires.
- *Must be installed, or connected by licenced electrician.
- *The Luminaires are intended for indoor use only.

Applications:

- Warehouses
- Supermarkets
- Shopping Malls
- Office Buildings
- Workshops
- Car Parks