



A-UNIQUE

ASIA UNIQUE LED LIGHTING CO., LTD

AU33 LED Downlight

Versatile Series

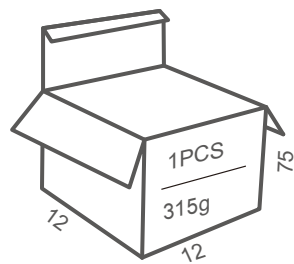
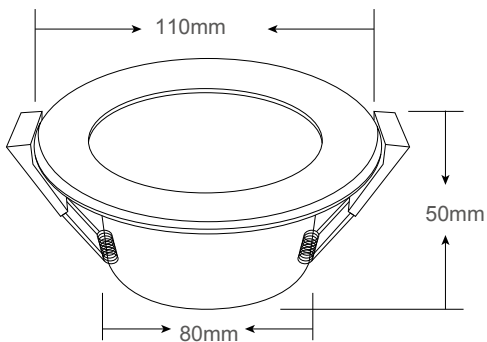
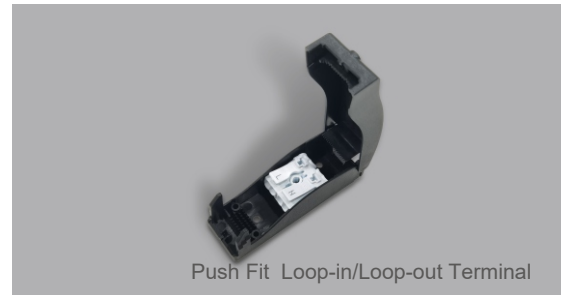

Inner box size (CM)

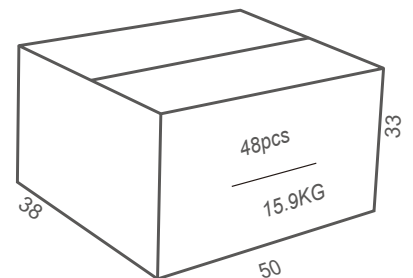

Carton size (CM)



General Features:

- Dual wattage control: 7W / 10W selectable or 8W / 12W selectable
- Tri-colour: WW / CW / DL selectable via switch on rear
- Interchangeable bezel: Can be white / black / polished silver /satin nickel
- Flicker Free Driver: For better visual comfort
- Triac Dimmable,Compatible to most branded dimmers, and C-bus2 system Fire
- Rated: 90mins - BS476-21 (For Europe)
- IP20 rated for the rear, IP44 rated for the front (IP65 rated for the front available)
- SAA, C-tick, CE and RoHS approved
- 3years warranty

Technical Specifications

Model No.	AU33-DL0710-3C		AU33-DL0812-3C	
Dimension(mm)	Ø110*H50		Ø110*H50	
Cutout(mm)	80-100		80-100	
Wattage(w)	7W /10W selectable		8W /12W selectable	
Input Voltage(v)	AC220~240V			
Light Source	SMD2835			
SDCM	<6			
CCT(K)	3 CCT	3000K-4000K-6500K		
Luminous Flux (lm)±5%	7W (750-840LM) - 10W (950-1100LM)		8W (820-950LM) - 12W (1010-1250LM)	
CRI	>80Ra (90Ra available)			
Beam Angle(°)	90°			
Dimming option	Triac Dimming			
Fire Rated	Available, if required			
Protection Class	Class II			
Degree of protection(IP)	IP20 for the whole luminaire, IP44 for the front portion of the lamp			
Material	Trim	Iron		
	Heat-sink	Iron		
	Diffuser	PC		
Color	Bezel	white / black / silver / satin nickel		
	Housing	white / black		
L70	>54000Hrs			
Operation Temp.(°C)	-20~ 45°C			
Installation	Recessed			
Certificates	CE, Rohs, SAA & C-tick			
Warranty	3 Years			

Packing information

Model Number	Weight/Luminaire (kg)	QTY/BOX (pcs)	Inner Box Size (mm)	Weight/Box (kg)	QTY/CTN (pcs)	Carton Size (cm)	Weight/CTN (kg)	QTY/20GP (PCS)	QTY/40GP (PCS)	QTY/40HQ (PCS)	QTY/40HQ (PCS)
AU33-DL0710-3C	0.262	1	120*120*75	0.315	48	50*38*33	15.9	17760	37008	46608	46608
AU33-DL0812-3C	0.262	1	120*120*75	0.315	48	50*38*33	15.9	17760	37008	46608	46608

Installation Instructions

Select the wattage and CCT via the switches
on the back of the downlight before the installation

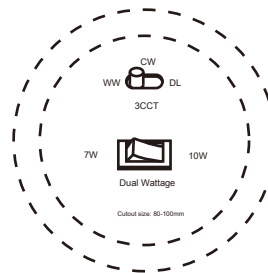

1. Open a hole according to the cutout size of led
downlight.

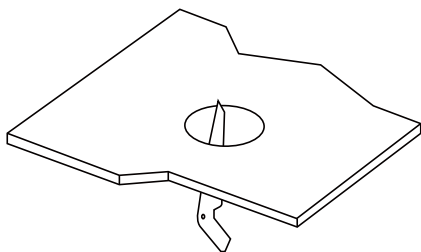

2.1 Use screw-driver to open the terminal cover,
feed the main AC wire L. N. in terminal block respectively,
then fix the terminal cover back (downlight with terminal type)

2.2 Insert the plug (downlight with plug type)

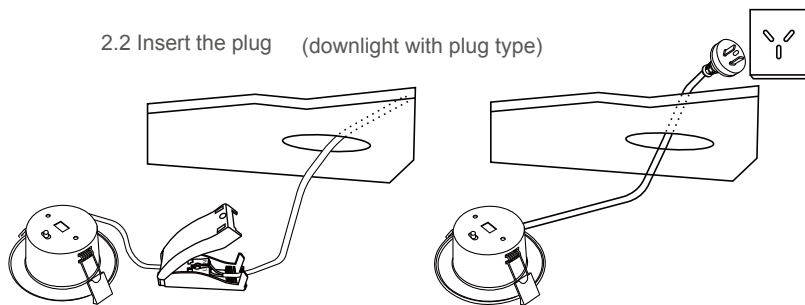

2.1

2.2

3. hold back the spring clip then push the downlight into the hole.

4. Make sure the downlight fixed tightly in ceiling,
turn on the power.

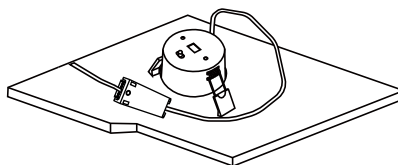
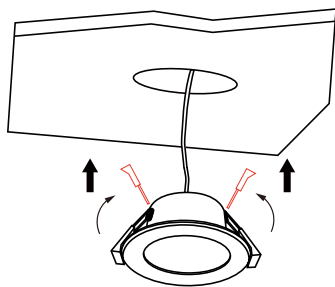

(downlight with terminal type)

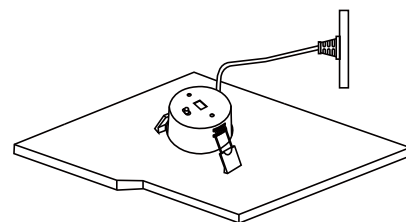

(downlight with plug type)

Please Note:

- * Turn off and isolate the electrical supply before connecting this fitting to the building wires.
- * Must be installed, or connected by licenced electrician.
- * The Luminaires are intended for indoor use only.

Applications:

- Hospitality applications
- Residential applications
- Office Buildings
- Hotels
- Shopping Malls
- Supermarkets