



A-UNIQUE

ASIA UNIQUE LED LIGHTING CO., LTD

NOVA LED Batten With Sensor

AU03-BAT
Series

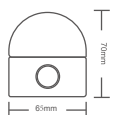
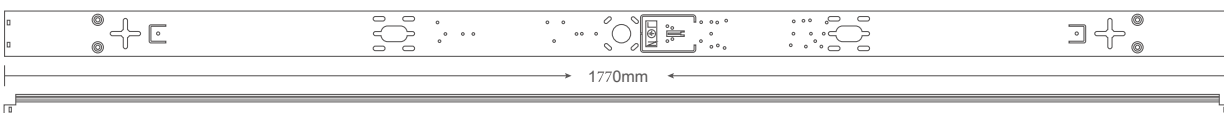
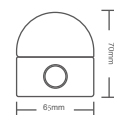
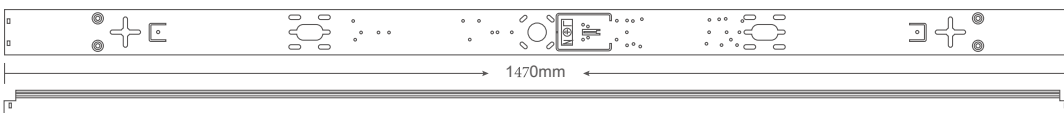
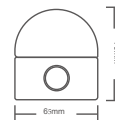
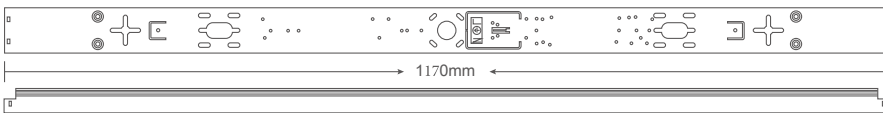
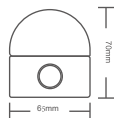
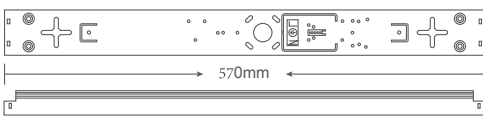
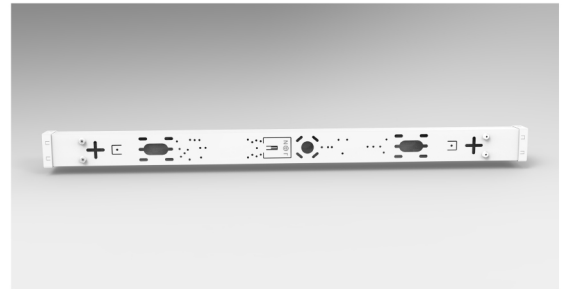



General Features:

- Wire from back or two ends, with big entry hole;
- Big Terminal Block or Quick play & plug connector, easy
- installation LED Replaceable board, very even light distribution
- One button to open the fixture, easy and fast
- The base and the diffuser are flexibly connected
- Suspension strap attached to the lamp & base part, makes installation easier
- Can be Surface Mounted or Suspended
- Can be linked one to another, end by end, without gap
- Triac Dimming, 1-10V Dimming & Dali Dimming available
- With Microwave motion & daylight sensor

Technical Specifications

Model No.	AU03-BAT18W2FXX-S	AU03-BAT36W4FXX-S	AU03-BATW5FXX-S	AU03-BAT60W6FXX-S
Dimension(mm)	600*65*70	1200*65*70	1200*65*70	1200*65*70
Cutout(mm)	/	/	/	/
Wattage(w)	18W	36W	50W	60W
Input Voltage(v)	AC220~240V			
Light Source	SMD2835			
SDCM	<6			
CCT(K)	1 CCT	2700K/3000K/4000K/5000K/5700K/6500K		
	3 CCT	3000K-4000K-5000K or 3000K-4000K-5700K or 4000K-5000K-5700K		
Luminous Flux (lm)?%	2160lm±5%	4320lm±5%	6000lm±5%	7200±5%
CRI	>80Ra			
Beam Angle(°)	120°			
Dimming option	Available			
Sensor option	Available			
Emergency Kits	Available			
Protection Class	Class I			
Degree of protection(IP)	IP20			
Impact Resistance(IK)	IK08			
Material	Base	Iron		
	Heatsink	Iron		
	Diffuser	PC		
L70	54000hrs			
Glow Wire Test(°C)	650°C			
Operation Temp.(°C)	-20~ 45°C			
Installation	Surface Mounted / Suspended			
Certificates	CE, Rohs, SAA & C-tick			
Warranty	3 Years			

Sensor Option 1: MC076S



Specification for Microwave Motion Sensor MC076S

- On-Off function
- Stand-by power $\leq 0.5W$
- Slim design, suitable for tri-proof light
- Special design with Needle antenna
- Detection area, hold time and daylight threshold can be precisely set by DIP switch

2.Parameter

Input	DC Input Voltage	$12 \pm 1V$ DC
	Rated Voltage	$12 \pm 0.6V$ DC
	Stand-by Power	$< 0.5W$
Output	Working Mode	5V high and low voltage signal, 0-10v signal
Sensor Parameters	Operating Frequency	5.8 GHz \pm 75 Mhz., ISM Band.
	Transmitting power	0.5mW Max.
	Hold time	5S/30S/1min/3min/5min/10min/20min/30min
	Stand-by DIM Level	10%(1.4-1.6V), 20%(1.9-2.1V), 30%(2.9-3.1V), 50% (4.9-5.1V)
	Twilight Time	0s/10S/1min/3min/5min/10min/30min/+ ∞
	Detection Area	25%/50%/75%/100%
	Daylight Sensor	5lux/15Lux/30Lux/50Lux/100lux/150lux/Disable Daylight priority: ON / OFF value (5lux/15Lux/30Lux/50Lux)/150Lux 100Lux/200Lux 150Lux/300Lux
	Detecting Radius	$\geq 4m$ (mounting height 3m, moving speed 0.3m/s)
	Mounting Height	6m Max
Operating Environment	Detecting Angle	150°
	Operating Temperature	-20°C \cdots +60°C
	Storage Temperature	Temperature: -40°C \cdots +80°C; Humidity: 10%-95% (non-condensing)
	EMC standards	EN55015, EN61000-3-2, EN61000-3-3, EN61547
Others	Environmental Requirement	Compliant to RoHS
	Wiring	3 pin 2.0mm fast connector

IP Rating	IP20
Protection Class	Class II
Installation	Base installation
Dimension	See dimension
Package	cartons
Net Weight	18g
Lifetime	5 years warranty@Ta 230V full load

Note

“1. N/A” means not available.

2. Detection area is effected on volume of motion object and motion speed. The detection area is tested 165cm height person and walking speed is 0.5m/s.

3. Function

1) On/OFF Function (stand-by period be set“to 0”s)

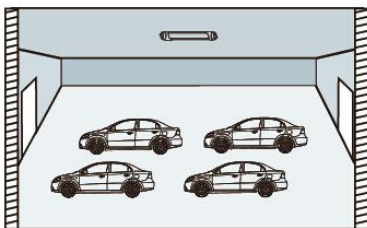

1 With sufficient ambient light, the light will not be switched on even if with motion signal.

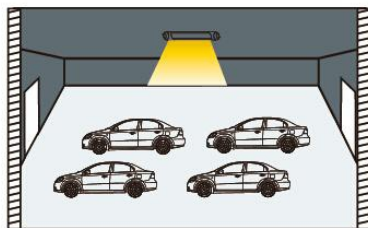

2 With insufficient ambient light, the sensor switches on the light when motion is detected.



3 After elapse of hold time, the sensor switches off the light when no motion is detected.

2) 2-step dimming function (stand-by period be set“to +∞”)

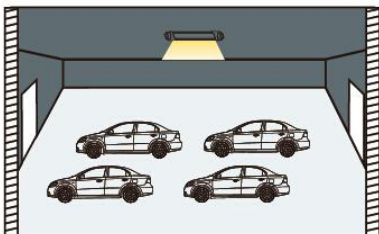

1 If there is no motion detected, the light will be remained at a low light level all the time.

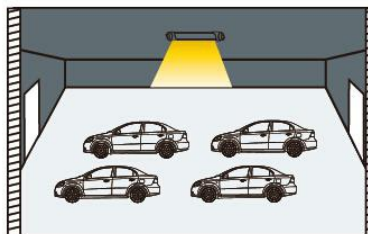

2 When motion is detected, the sensor will switch on the light to 100% brightness

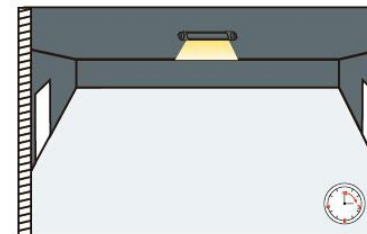

3 After elapse of hold time, the sensor dims the light at the present low light level if no motion is detected.

3) 3-step dimming function (stand-by period be set“to 10S/1min/3min/5min/10min/30min”)

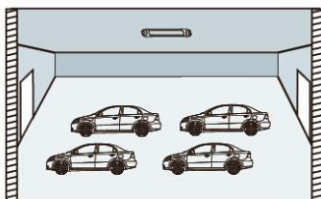

1 With sufficient ambient light, the light will not be switched on even if with motion signal.

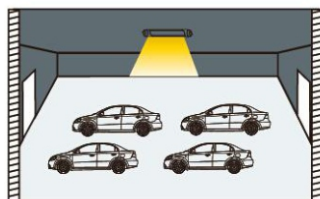

2 With insufficient ambient light, the sensor switches on the light when motion is detected.

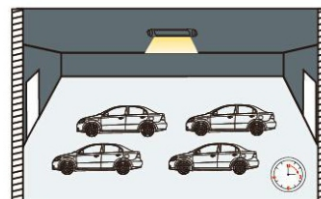

3 After elapse of hold time, the sensor dims the light at a low light level if no new motion is detected.



4 After elapse of standby period, the sensor switches off the light if no motion is detected in the detection zone.

4. Dimension(mm)

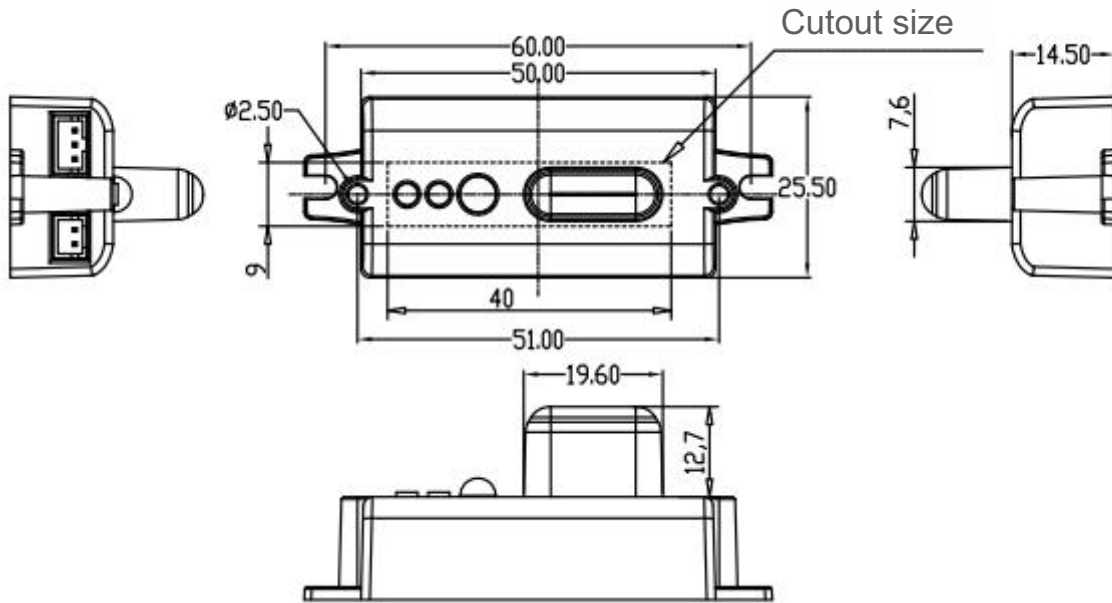

5. Wiring

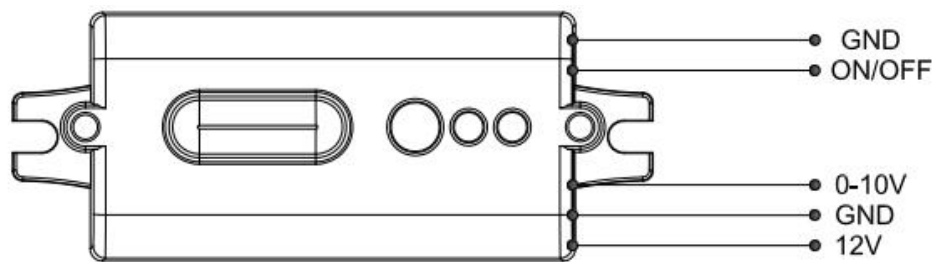

*Without auxiliary 12Vdc interface driver, MC103S can be an option of power supply for sensor

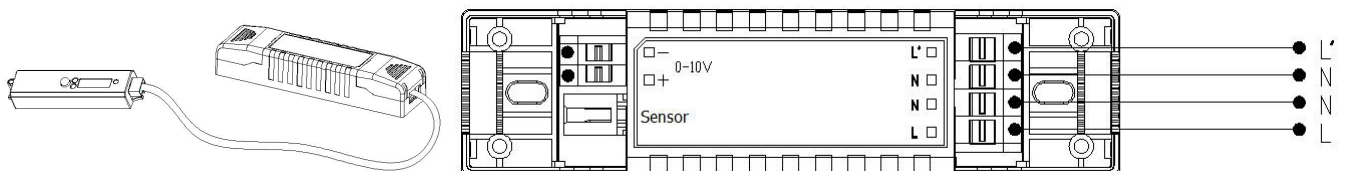

6. Structure and installation

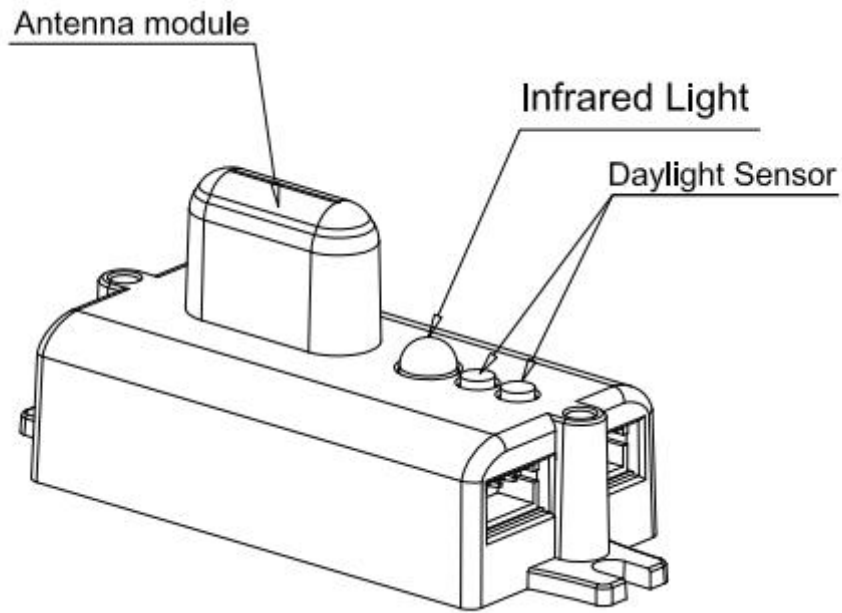

7. Radiation Pattern

Ceiling mounting

Ceiling mounted height: 3m
Sensitivity: 100%/75%/50%/25%

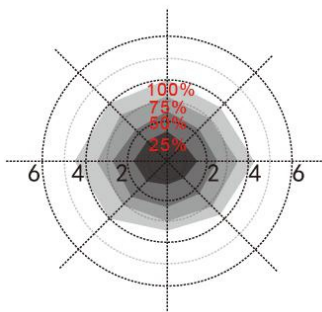

Normal moving (Speed:1m/s)

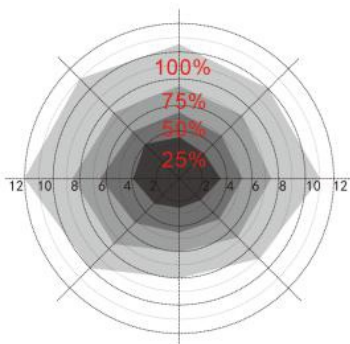

Slow moving (Speed 0.3m/s)

Ceiling mounted height: 4m
Sensitivity: 100%/75%

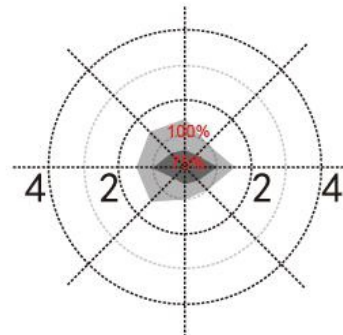

Normal moving (Speed:1m/s)

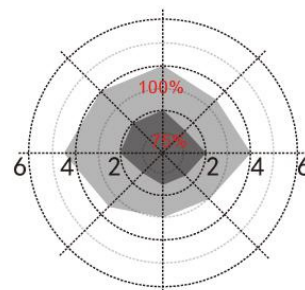

Slow moving (Speed 0.3m/s)

*Only 100% detection sensitivity is workable when installed at 4m mounting height. 25% /50% sensitivity is not able to detect motion signal.

Wall mounting

Horizon mounted height: 2m
Sensitivity: 100%/75%/50%/25%

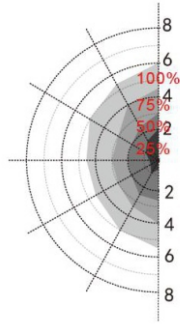

Normal moving (Speed: 1m/s)

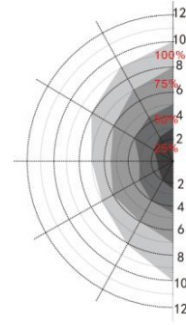

Slow moving (Speed 0.3m/s)

8. Remote control

Remote Control Setting	Button	Remarks																												
	ON/OFF	Press the "ON/OFF" button, the light goes to constant on/off mode, sensor is disabled. Press "Reset" "Auto mode" button to quit from this mode and the sensor starts to work.																												
	Reset	Press "Reset" button, all parameters are same as setting of DIP switch or factory settings.																												
	Sensor motion	Press "Sensor motion" button, the light quits from the constant on/ off mode, and the sensor starts to work (The latest setting stays in validity)																												
	DIM Test	Press "DIM Test" button, the 1-10 V dimming works to test whether the 1-10Vdc dimming ports are connected properly. After 2s, it returns to the latest setting automatically.																												
	Dvrride DH	Long press 3s, Daylight priority mode will be switched to daylight threshold mode, lux value will go back to previous one.																												
	DIM+ DIM-	Short press "DIM+/DIM-" button to Set the output lumen level, each press will will $\pm 2\%$ light level																												
	DH Mode	Long press >3s, sensor will be switched to daylight priority mode; if preset daylight value is Disable, press DH Mode can not start daylight priority mode.																												
	Q1 Q2 Q3	<table border="1"> <thead> <tr> <th>Scene Options</th> <th>Detection Area</th> <th>Hold Time</th> <th>Stand-by period</th> <th>Stand-by dim level</th> <th>Daylight Sensor</th> <th>Induction model</th> </tr> </thead> <tbody> <tr> <td>QS1</td> <td>100%</td> <td>5min</td> <td>10min</td> <td>10%</td> <td>30Lux</td> <td>Hs</td> </tr> <tr> <td>QS2</td> <td>100%</td> <td>10min</td> <td>30min</td> <td>10%</td> <td>Disable</td> <td>Hs</td> </tr> <tr> <td>QS3</td> <td>100%</td> <td>20min</td> <td>30min</td> <td>10%</td> <td>Disable</td> <td>Hs</td> </tr> </tbody> </table> <p>Note: Detection area / Hold time /Stand-by period /Stand-by dim level / Daylight sensor can be adjusted by pressing the corresponding button. The latest setting will stay valid.</p>	Scene Options	Detection Area	Hold Time	Stand-by period	Stand-by dim level	Daylight Sensor	Induction model	QS1	100%	5min	10min	10%	30Lux	Hs	QS2	100%	10min	30min	10%	Disable	Hs	QS3	100%	20min	30min	10%	Disable	Hs
Scene Options	Detection Area	Hold Time	Stand-by period	Stand-by dim level	Daylight Sensor	Induction model																								
QS1	100%	5min	10min	10%	30Lux	Hs																								
QS2	100%	10min	30min	10%	Disable	Hs																								
QS3	100%	20min	30min	10%	Disable	Hs																								
	TEST 2S	Press the "TEST 2S" button can enter the test mode any time. At the mode, the sensor parameters as below: Detection Area is 100%, Hold Time is 5s, Stand-by Dim Level is 10%, Stand-by Period is 0s, daylight sensor disable. This function only for testing. Quit the mode by pressing "RESET" or any other function buttons.																												
	HS LS	Press "HS" button to set the detection area to be high sensitive. Press "LS" button to set the detection area to be low sensitive. The adjustment bases on the "Detection Area" parameter you set.																												
	Daylight Sensor	Set up daylight threshold: 5Lux/15Lux/30Lux/50Lux/100Lux/150Lux/ Disable.																												
	Stand-by period	Set up stand-by time: 0S/10S/1min/3min/5min/10min/30min/+∞																												
	Hold time	Set up hold time: 5S/30S/1min/3min/5min/10min/20min/30min																												
	Stand-by dim level	Set up stand-by dim level: 10%/20%/30%/50%																												
	Detection Area	Set up detection area: 25%/50%/75%/100%																												
	Remote Distance	Toggle button can set the remote distance of remote control and sensor.																												

9. Factory Setting

Detection area: 100%, Hold Time: 5S, Stand-by Period: 0s, Stand-by dim level: 10%, Daylight Sensor: Disable

10. Application Notice

- 1) The sensor should be installed by a professional electrician. Please turn off the power before installing, wiring, changing the setting of the DIP switch.
- 2) The sensor which installed in the plastic and glass lampshade will reduce the sensitivity. For every 3mm increase in thickness, the sensitivity will be reduced by 20%.
- 3) The dimming performance could be different from different 0/1-10v drivers.
- 4) The light sensitivity threshold is in a sunny environment, no shadow and ambient light diffuse reflection. Ambient lux level could be different in different environment, weather, climate, time-of-day and season.
- 5) The parameters of the sensor may need to be reconfigured in different installation environments. Please refer to the following instructions or contact the manufacturer.
- 6) Sensor could be triggered by wind and rain, as well as the moving objects nearby, if apply outdoor.
- 7) The mounting height is no more than 4m, proper mounting height is 3m; the distance between any inductive sensors should be greater than 3m.
- 8) Do not place the sensor close to high-density objects such as metal, glass, concrete walls, etc, false triggering could happen. When the sensor is installed in a metal lamp, metal reflective surface, or a narrow enclosed environment, the microwave will be reflected repeatedly and cause false triggering. Please reduce the sensitivity or contact the manufacturer for technical support.
- 9) Please ensure that there are no moving signals around the sensor, such as fan, DC motor, sewer pipe, air outlet, etc., the sensor may generate false trigger.
- 10) You are advised to test 5 samples before mass application of sensor in a new lighting project.
- 11) Due to continuous improvement, the contents of this instruction could be changed without prior notice

Sensor Option 2: ED164S-Y-R6

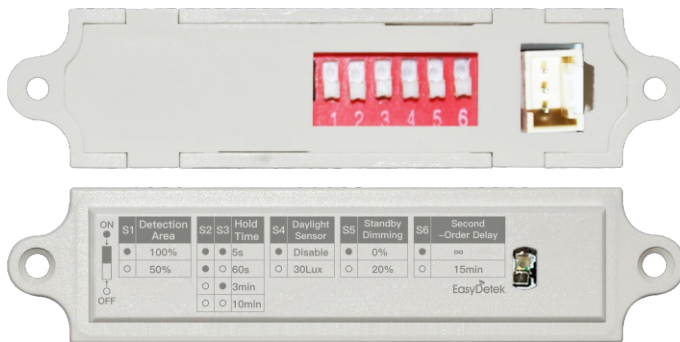

Feature & Advantage

- Compared with the infrared sensor module, the sensing distance is longer and the angle is wider, there is no dead zone, lens and lens aging problem;
- Not affected by temperature, humidity, airflow, dust, noise, brightness, etc., and has stro anti-i terference ability;
- Can penetrate acrylic, glass and thin non-metallic ma
- Built-in MCU, embedded multiple digital filtering algorithms, with higher immunity;
- Output 0-10V, matching the 0-10V dimming power supply on the market.

Characteristic Description



Distance Customize



DelayTime



Various output modes



Daylight Optional

Be sure to power off before adjusting DIP switch setting.

Setting

Factory Setting: Detection Area 100%, Hold Time 3min, Daylight Sensor Disable, Standby Dimming 20%, Second-Order Delay 15min.

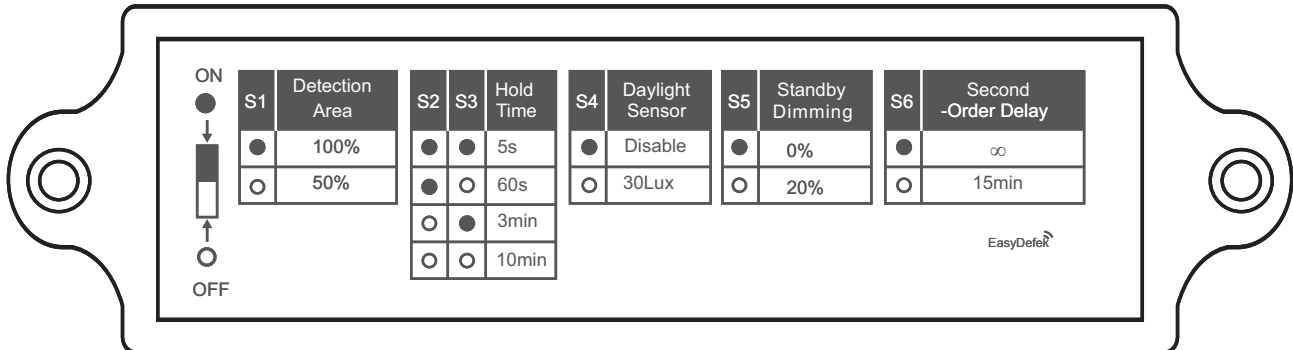

1. Hold Time refers to the time period the lamp remains at 100% illumination after no motion detected.
2. Disable means the daylight sensor does not work. When set to Disable mode, the daylight sensor will switch on the lamp when motion is detected, Regardless of ambient light level. 30lux is twilight operation.
3. Standby Dimming is the low light level that you would like to have after the hold time in the long absence of people.
4. Second-Order Delay refers to the time period the lamp remains at a low light level before it completely switches off in the long absence of people. When set to "∞", the low light is maintained until motion is detected. When set to "15min", the light will turn off after 15min.

Application Demo



1. When the ambient light is bright enough, the light will not automatically light up even if a moving object is detected.

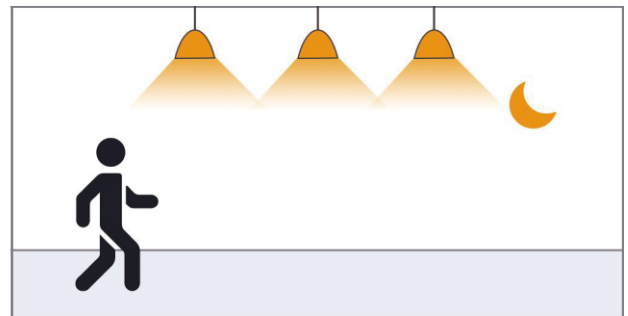

2. When the ambient light is lower than the preset photosensitive threshold, the light will automatically light up when the sensor detects a moving object.

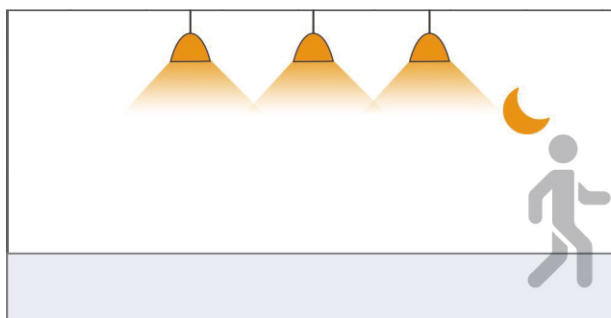

3. After the moving object leaves, the sensor will enter the delay time when it cannot detect the moving object and keep the light on.

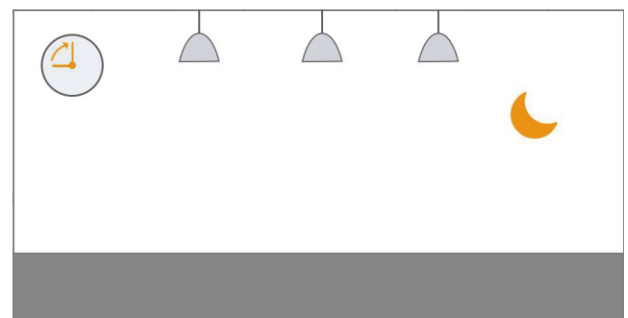

4. After the preset delay time, the light will automatically turn off.

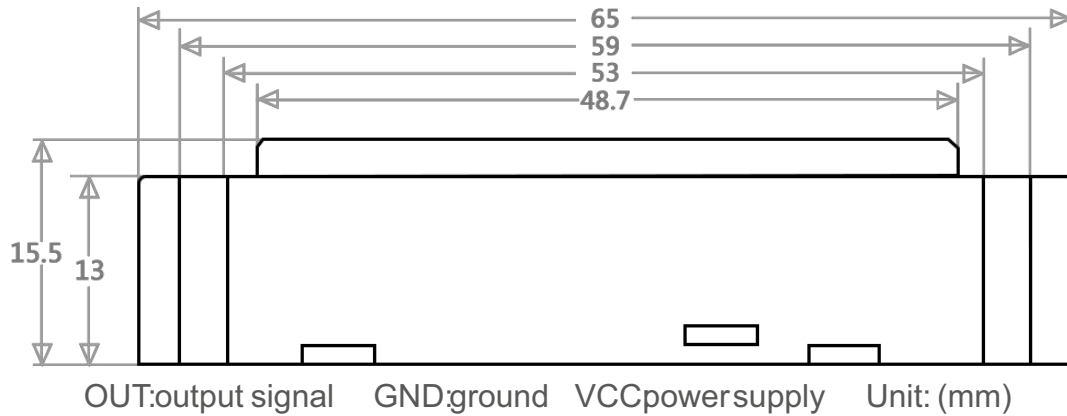
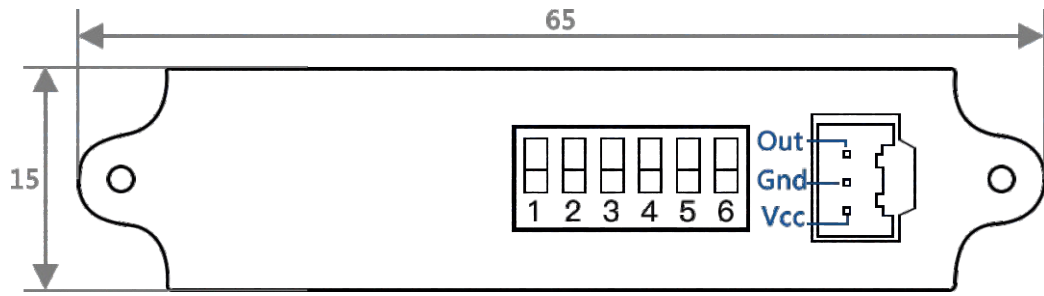

Specification

parameter	Minimum	Typical value	Max	Unit	Remarks
Transmit frequency	5.725	5.8	5.875	GHz	-
Input voltage	9	10	12	V	-
The output voltage	0	-	10	V	IOH=30uA
3db beam angle	-	97	-	°	XZ plane
	-	90	-	°	YZ plane
Working current	42	46	48	mA	CW mode
Sensing distance	4	5	6	m	Note 1
Delay time	-	5	-	s	Note 2
Photosensitive threshold	-	30	-	Lux	Note 3
Operating temperature	-25	-	85	°C	-
storage temperature	-50	-	125	°C	-

- Note 1: The test takes 3m as the test condition, and the range radius is the ground sensing distance;
- Note 2: The delay time can be customized according to customer needs;
- Note 3: The trigger intensity of the photosensitive switch can be customized or the photosensitive control can be cancelled according to customer needs.

Detection diagram

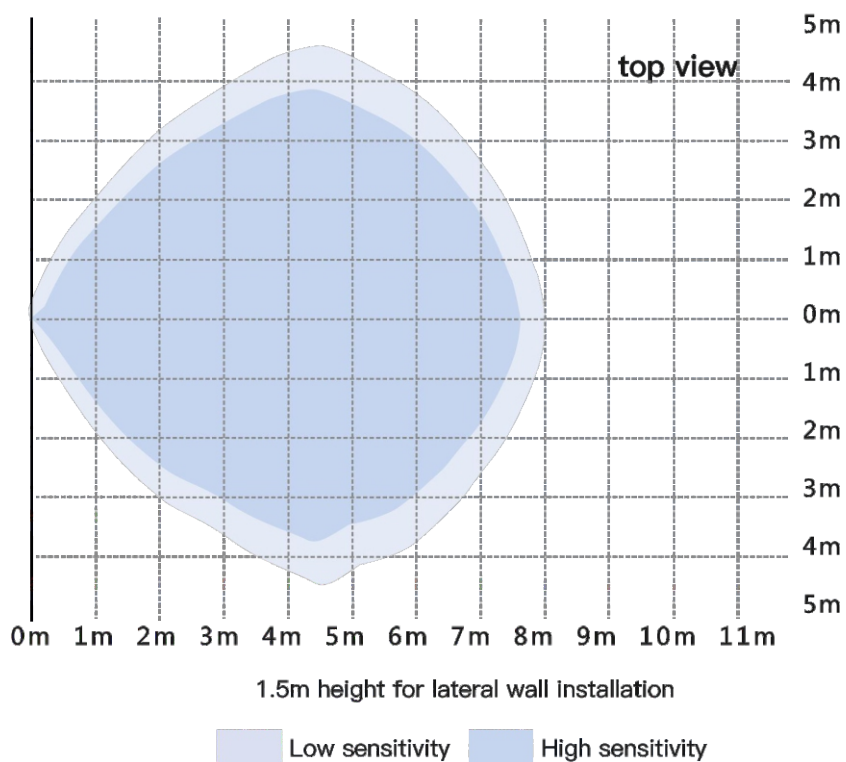
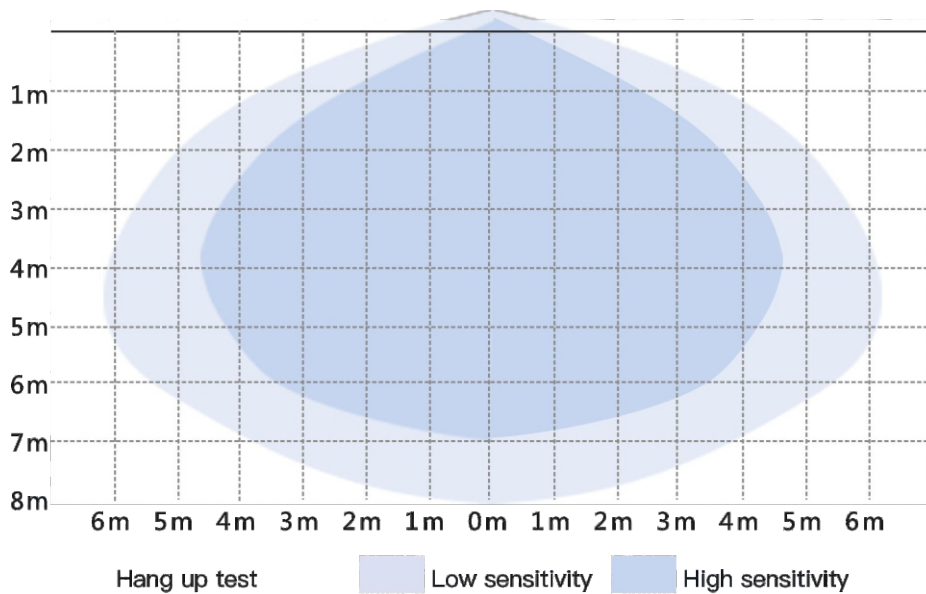

*Note: The distance can be adjusted according to the actual application

Dial definition

6-digit dial code, the terminal definition is as follows

ON ●→■□←○ OFF

Distance	Delay time	Photosensitive threshold	Second order brightness	Second time
1	2 3	4	5	6
● 100%	● ● 5s	● Disable	● 0%	● ∞
○ 50%	● ○ 60s	○ 30Lux	○ 20%	○ 15min
	○ ● 3min			
	○ ○ 10min			

Typical application

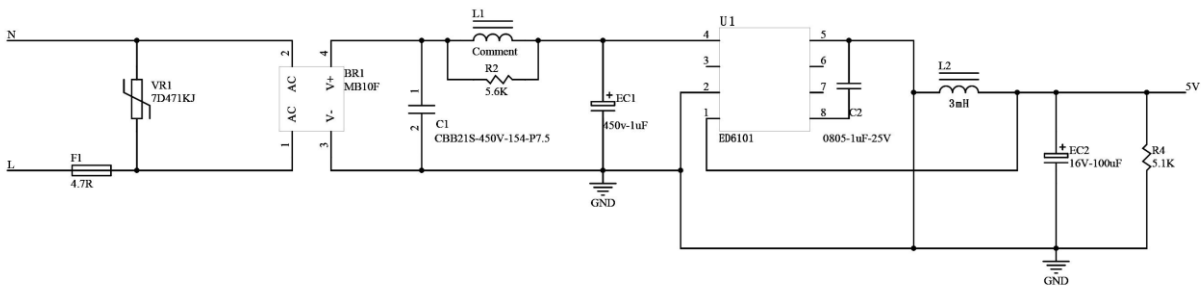
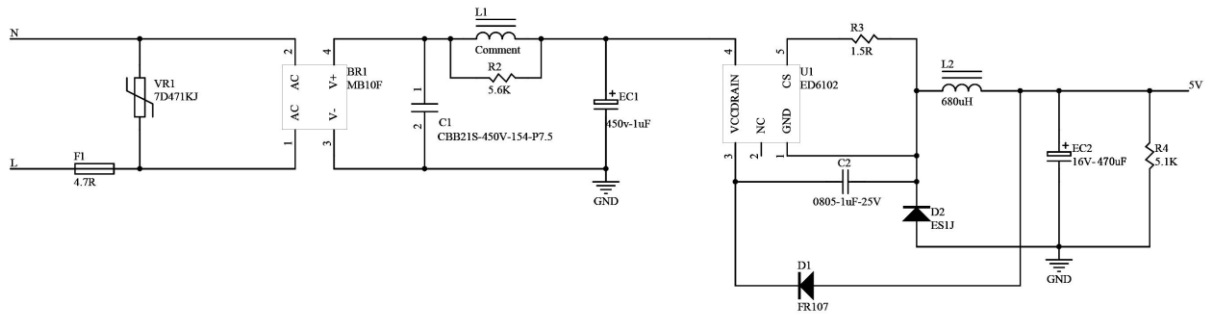

*Note: OUT output can be customized in ON/OFF mode or PWM dimming mode

Installation Instructions

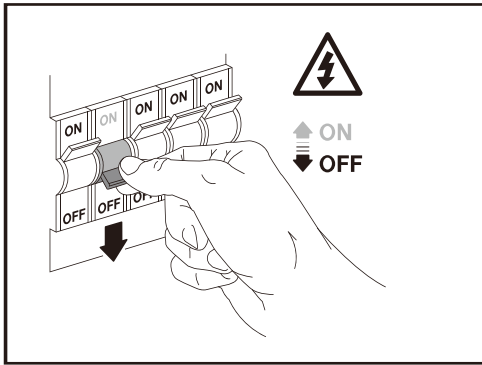

1

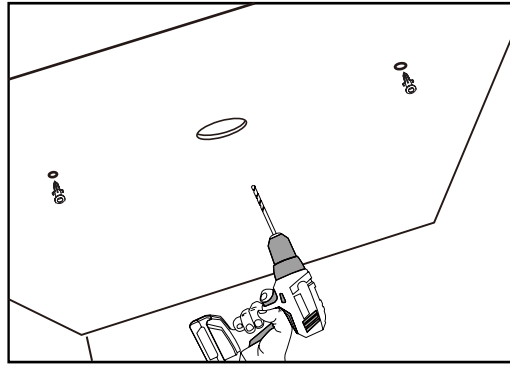

2

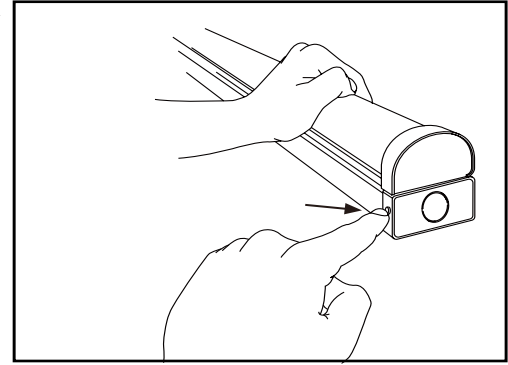

3

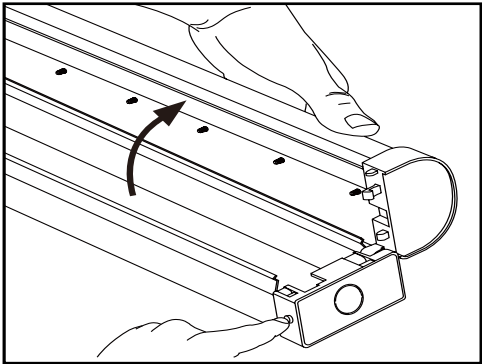

4

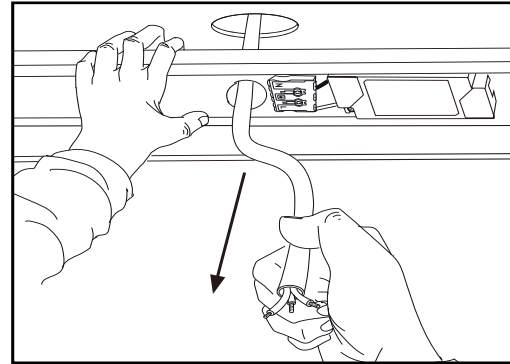

5

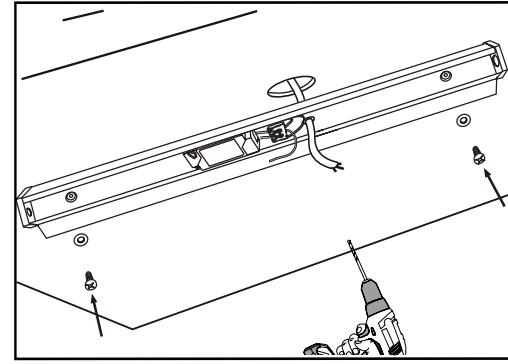

6

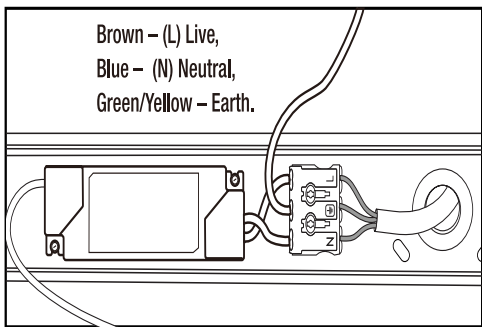

7

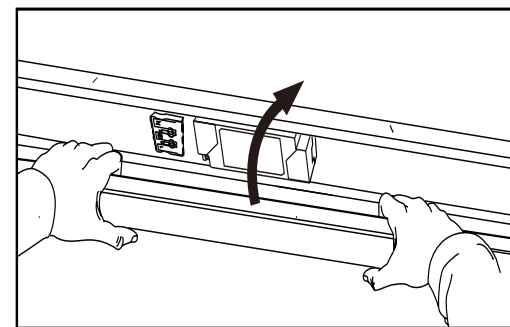

8

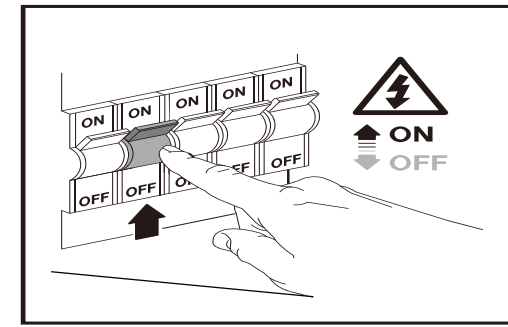

9

Please Note:

- *Turn off and isolate the electrical supply before connecting this fitting to the building wires.
- *Must be installed, or connected by licenced electrician.
- *The Luminaires are intended for indoor use only.

Applications:

- Warehouses
- Supermarkets
- Shopping Malls
- Office Buildings
- Workshops
- Car Parks