



A-UNIQUE

ASIA UNIQUE LED LIGHTING CO., LTD

NOVA LED Batten

AU03-BAT Series

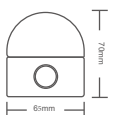
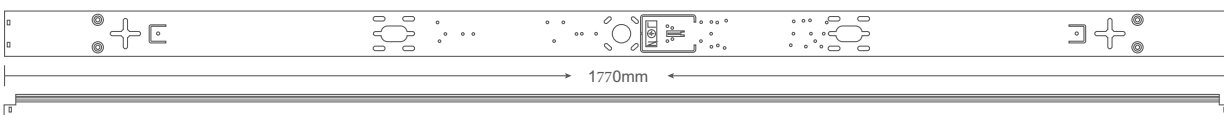
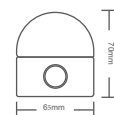
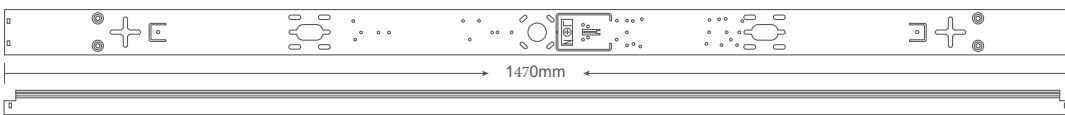
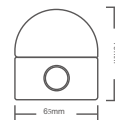
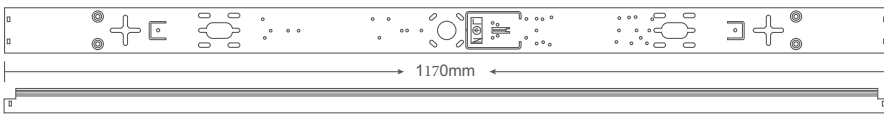
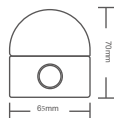
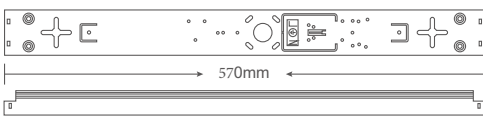
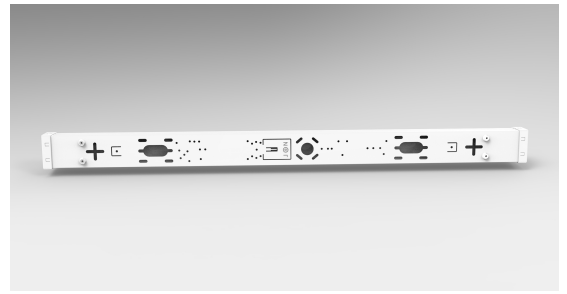

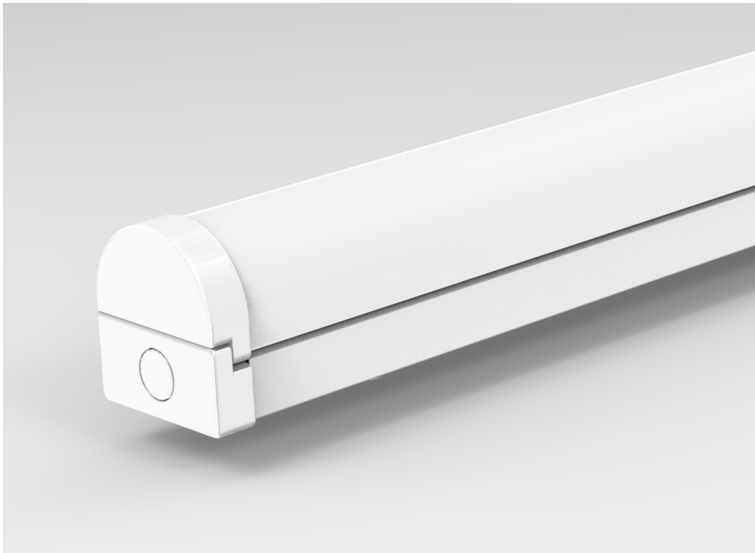

General Features:

- Wire from back or two ends, with big entry hole;
- Big Terminal Block or Quick play & plug connector, easy
- installation LED Replaceable board, very even light distribution
- One button to open the fixture, easy and fast
- The base and the diffuser are flexibly connected
- Suspension strap attached to the lamp & base part, makes installation easier
- Can be Surface Mounted or Suspended
- Can be linked one to another, end by end, without gap
- Tri-color, Sensor & Emergency versions are available
- Triac Dimming, 1-10V Dimming & Dali Dimming available

Technical Specifications

Model No.	AU03-BAT20W2FXX	AU03-BAT30W4FXX	AU03-BAT36W4FXX	AU03-BAT40W5FXX	AU03-BAT50W5FXX	AU03-BAT60W6FXX
Dimension(mm)	600*65*70	1200*65*70	1200*65*70	1500*65*70	1500*65*70	1800*65*70
Cutout(mm)	/	/	/	/	/	/
Wattage(w)	20 W	30W	36W	40W	50W	60W
Input Voltage(v)	AC220~240V					
Light Source	SMD2835					
SDCM	<6					
CCT(K)	1 CCT	2700K/3000K/4000K/5000K/5700K/6500K				
	3 CCT	3000K-4000K-5000K or 3000K-4000K-5700K or 4000K-5000K-5700K				
Luminous Flux (lm)?%	2400lm±5%	3600lm±5%	4320lm±5%	4800lm±5%	6000lm±5%	7200 lm±5%
CRI	>80Ra					
Beam Angle(°)	120°					
Dimming option	Available					
Sensor option	Available					
Emergency Kits	Available					
Protection Class	Class I					
Degree of protection(IP)	IP20					
Impact Resistance(IK)	IK08					
Material	Base	Iron				
	Heatsink	Iron				
	Diffuser	PC				
L70	54000hrs					
Glow Wire Test(°C)	650°C					
Operation Temp.(°C)	-20~ 45°C					
Installation	Surface Mounted / Suspended					
Certificates	CE, Rohs, SAA & C-tick					
Warranty	3 Years					

Packing information

Model Number	Weight/Luminaire (kg)	QTY/BOX (pcs)	Inner Box Size (mm)	Weight/Box (kg)	QTY/CTN (pcs)	Carton Size (cm)	Weight/CTN (kg)	QTY/20GP (PCS)	QTY/40GP (PCS)	QTY/40HQ (PCS)
AU03-BAT20W2FXX	0.80	1	615*70*75	0.9	8	62*29.5*17	7.9	7232	15152	17176
AU03-BAT30W4FXX	1.60	1	1215*70*75	1.8	8	122*22.5*17	11.3	3222	7332	8412
AU03-BAT36W4FXX	1.60	1	1215*70*75	1.8	6	122*22.5*17	11.3	3222	7332	8412
AU03-BAT40W5FXX	2.00	1	1515*70*75	2.35	6	152*22.5*17	15.0	2730	5928	6768
AU03-BAT50W5FXX	2.00	1	1515*70*75	2.35	6	152*22.5*17	15.0	2730	5928	6768
AU03-BAT60W6FXX	2.40	1	1815*70*75	3.00	6	182*22.5*17	19.0	2220	4620	5820

Installation Instructions

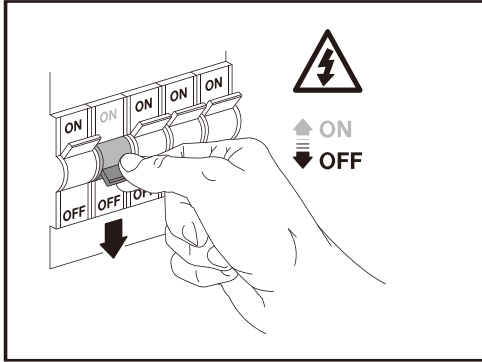

1

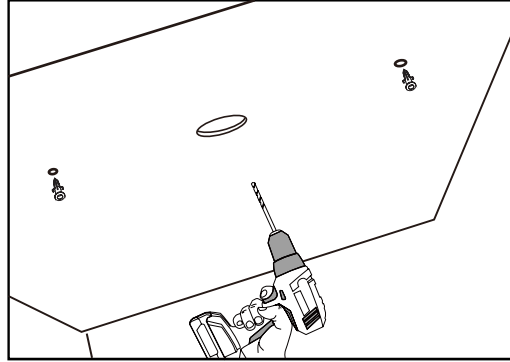

2

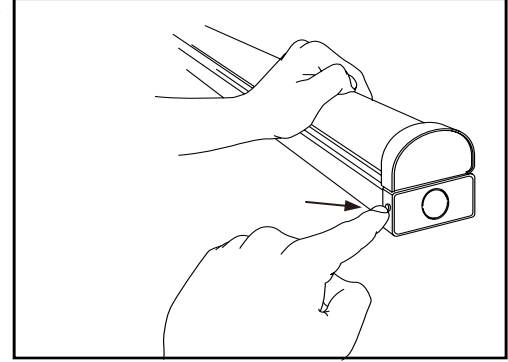

3

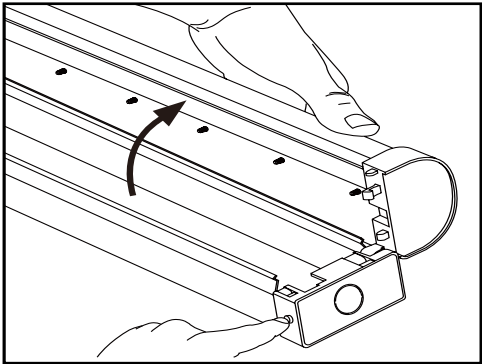

4

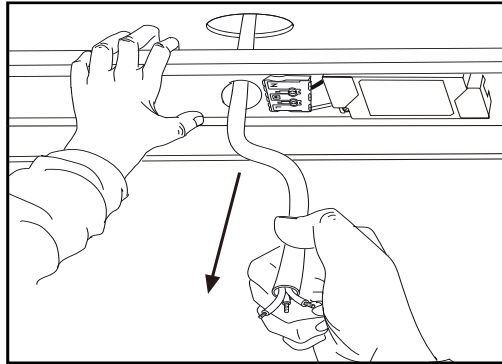

5

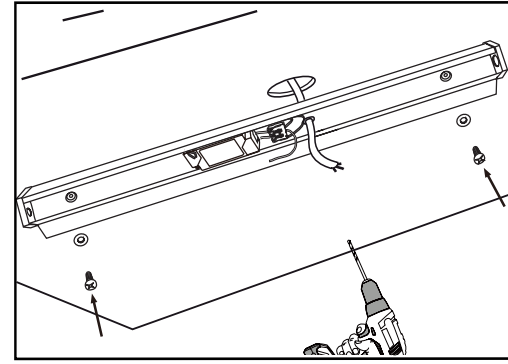

6

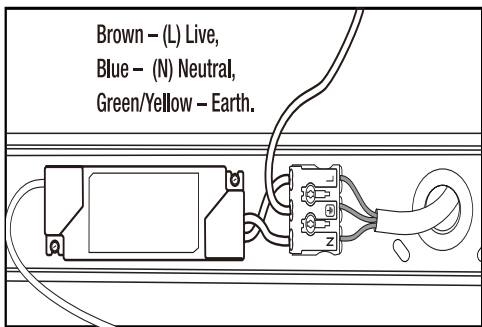

7

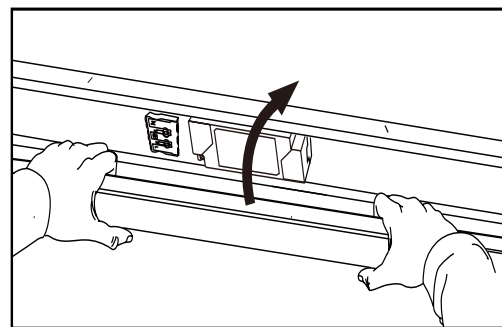

8

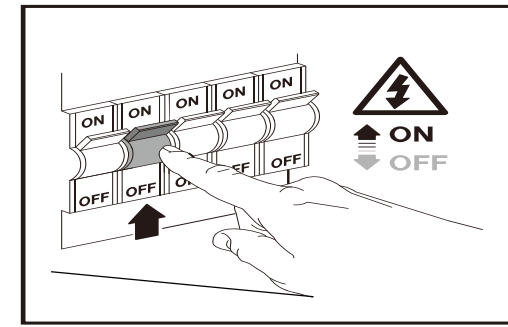

9

Please Note:

- *Turn off and isolate the electrical supply before connecting this lighting to the building wires.
- *Must be installed, or connected by licenced electrician.
- *The Luminaires are intended for indoor use only.

Applications:

- Warehouses
- Supermarkets
- Shopping Malls
- Office Buildings
- Workshops
- Car Parks